



ASHAPOWER[®]
Digital Systems & Solar Solutions

Vers.3.3



SURYA -60

**SOLAR MPPT CHARGE CONTROLLER
MULTI VOLTAGE RANGE**

USER MANUAL

SURYA -60 SOLAR MPPT CHARGE CONTROLLER

ASHAPOW[®] SURYA-60 Solar MPPT Charge Controllers are multi voltage range devices that are unique in its kind in the market. The same device can be used for battery banks ranging from 1 Battery(12V) up to a battery bank of 2 batteries (24V) in series. The battery voltage is selected by the device itself when we connect the battery bank across its terminal. The device gives a configurable charging current up to 40A. The Max PV panel input open circuit voltage up to 140V makes it easier to group the panels conveniently. Also, sleek & stylish design of the product gives a better aesthetic view so that you can wall mount the product in a visible place inside your home or office.

SALIENT FEATURES









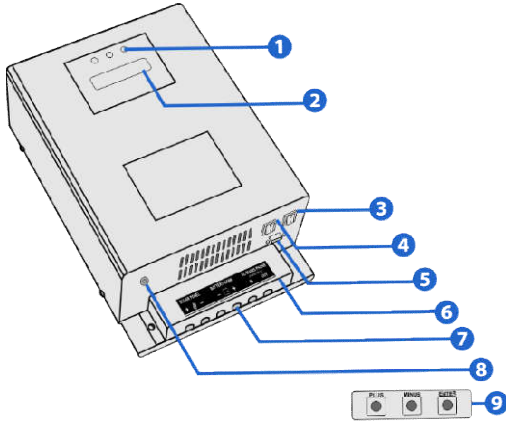

- Compatible for 12/24V Battery Bank
- Auto-Detection and setting of Battery Bank.
- Smart charging for prolonged battery life.
- Ultra-fast & efficient (98.9%) power point tracking.
- PV panel reverse polarity protection.
- Automatic disconnection of PV panels at night.
- Over voltage protection from PV panel.
- Protection for battery against hardware failures.
- Over charging & overload protection.

SURYA -60

Max PV Array Open Circuit Voltage (Voc)	140V
Max PV Array Watts Applicable	1600W
Nominal Battery Voltage	12/24 V (Auto Setting)
Maximum Charging Current	60A (Configurable)
Maximum Tracking Efficiency	98.9%
Standby Power Consumption	<1.5W
Overload Protection	✓
Over Charge Protection	✓
Panel Reverse Polarity Protection	✓
Battery Reverse Polarity Protection	Optional
Dimensions – L x W x H (mm)	318x215x112
Net Weight (Kgs)	3.4Kgs
Connector	Input / Output Terminal Block
Communication	Display/UART

KNOW YOUR DEVICE



1	LED Indicators	  
2	2X16 LCD	
3	GRID Bypass Switch	
4	MPPT ON-OFF Switch	
5	Settings D-Connector	
6	Terminal Cover	
7	I/O Power Terminals	
8	Solar/Grid Monitor Port	
9	Settings Key	

INDICATOR	ON	OFF	BLINKING
BLUE SOLAR/GRID POWER STATUS	LOAD IS ON SOLAR POWER	LOAD IS ON GRID POWER	BATTERY LOW WARNING TO AVOID HEAVY LOADS
GREEN SOLAR OUTPUT STATUS	PV PANEL VOLTAGE IS HIGHER THAN BATTERY BANK VOLTAGE	PV PANEL VOLTAGE IS LOWER THAN BATTERY BANK VOLTAGE / OR NO PV PANEL CONNECTED	BATTERY CHARGING AND SHARING TO CONNECTED LOAD
RED SOLAR CHARGING STATUS	SOLAR CHARGING CURRENT IS DETECTED MORE THAN 2 AMPS. CHARGING STARTS	SOLAR CHARGING CURRENT IS LESS THAN 2 AMPS. CHARGING STOPS	-

INSTALLATION & OPERATION

1.PV Panel Grouping: Using required Solar MC4 connectors and parallel connectors, group the PV panel array according to the recommended grouping chart provided. Good quality weather proof solar cables must be used.

2.Battery Bank Setup: If more than one battery is used, Connect the interlinking cables (16 sq.mm minimum) tightly and check each battery separately for specific gravity and backup.

3.MPPT Charge Controller Installation:-

- Mount the MPPT charge controller vertically on the wall.
- Never keep any object on the device blocking the cooling fan.
- Avoid exposure to rain, direct sunlight or high temperature.
- Remove the terminal cover of the device and make sure the device is switched off.
- Connect the device to the battery bank using 16sq.mm/10Sq.mm standard cables.
- Connect the cables from PV panels to the solar terminals of the device with correct polarity.
- Switch ON the Power switch of the device. Three LED Indicators and cooling fan of the device starts functioning for 5 seconds and goes off. **Display shows the voltage of the connected battery bank and applicable range of PV Panel Open Circuit Voltage (Voc) limit for the connected battery bank.Ensure the displayed battery bank voltage and connected battery bank voltage are same when MPPT is powered ON.**The Charger starts functioning when the PV Panel voltage detected is higher than the connected battery bank voltage and green LED lights up. If the PV panel voltage goes below the battery bank voltage the green indicator goes off. When the device detects more than 2A charging current to the battery, RED LED lights up. If the current is less than 2A the RED LED goes off. When the battery voltage reaches 14.0V(Configurable) the BLUE LED lights up and the phase input to the inverter connected through the MPPT will be blocked. Now the load starts functioning on inverter (Solar). When the solar charging current stops the load will be taken from the battery bank and the battery voltage goes down. Once it reaches 11.0V(Configurable) the device change over the load from inverter to grid power and the blue LED goes off. Blinking blue LED indicates Low battery bank voltage ie.11.7V (Configurable)giving warning to remove heavy loads.The blinking of green LED indicates sharing of solar current for battery charging and connected load. Solar/Grid status can also be monitored remotely by connecting an LED to the Solar/Grid Monitor Port for a distance up to 30 meters with wire.

- Automatic Grid/Solar power Change Over:-

If the Automatic Grid/Solar power Change Over is required, follow the instructions below: - Connect the grid power phase wire (using 4sq.mm/6sq.mm) to the '**Phase In**' part of the terminal on the device. Connect another wire from the '**Phase Out**' part of the terminal to the input phase connector of the inverter. (Never connect the neutral of the grid power to any terminal of the charger. Refer Connection diagram provided).

RECOMMENDED GROUPING OF PV PANELS

- Recommended PV Panel Input voltage for maximum MPPT performance.

Battery Bank Volt	Max.PV Panel Voltage Range (Voc)	Example for Grouping of PV Panels in Series	Max.PV Panels Applicable in Watts
12V	30-120V	1) 47V Voc (335w panel) x 2panel in series = 94Voc =670W 2) 21V Voc (150w panel) x5 in series= 105Voc=750w	800W
24V	60-140V	36V Voc(260wpanel) x3 panel in series=108Voc=780w X2Strings in parallel =1560W	1600W

Note: Solar panels should be grouped in such a way that the Open Circuit Voltage (Voc) of the panels connected in series should not exceed the Maximum panel voltage mentioned above for each battery bank!

CONNECTION DIAGRAM

750W/12V OFFGRID SOLAR POWER PLANT

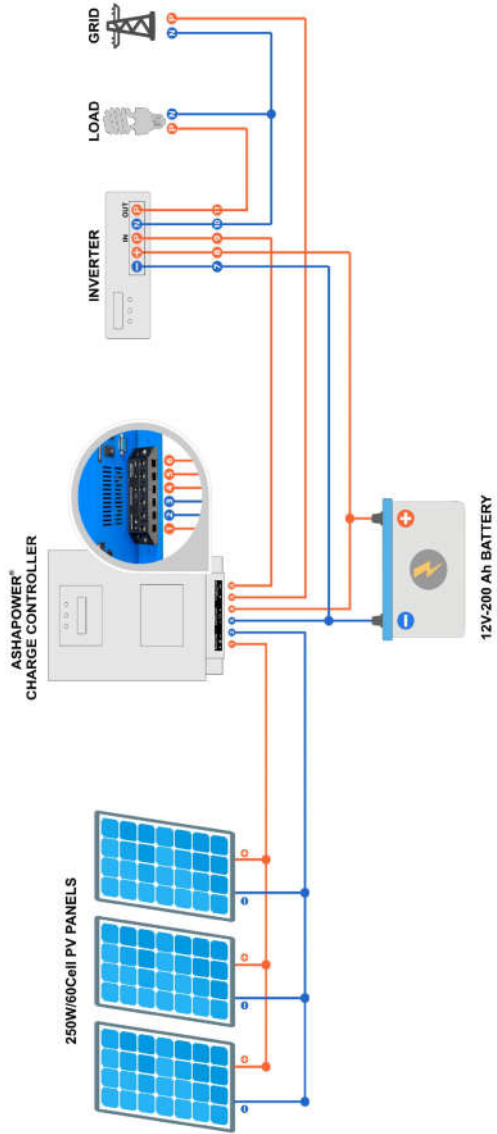

CONNECTION DIAGRAM

1500W/24V OFFGRID SOLAR POWER PLANT

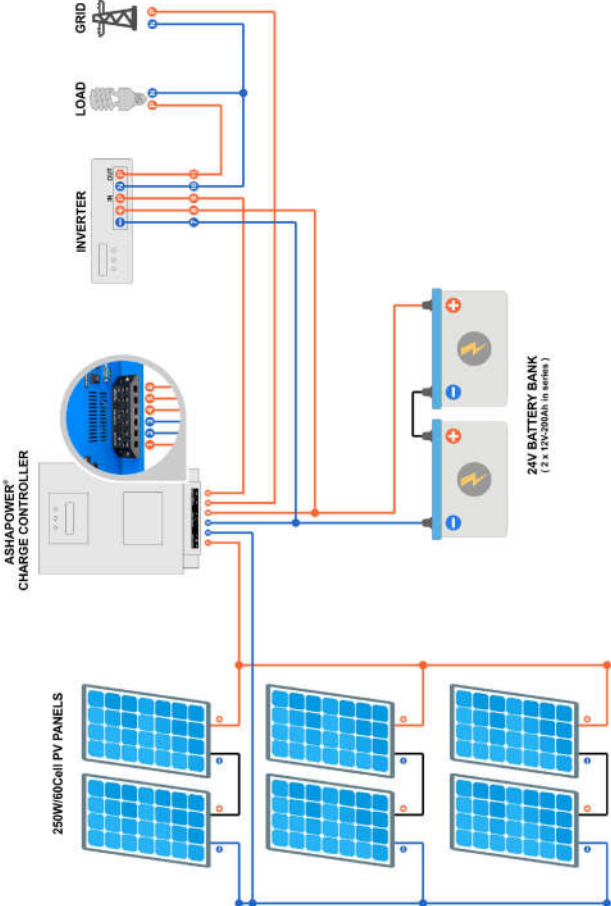

TROUBLE SHOOTING

ERROR CODE	DESCRIPTION	SOLUTION
EV	PV PANEL VOLTAGE ERROR	PV PANEL VOLTAGE IS NOT IN THE SPECIFIED LIMIT. CHECK FOR PV PANEL GROUPING. REFER PV PANEL GROUPING MANUAL PROVIDED.
EB	BATTERY BANK VOLTAGE ERROR	CONNECTED BATTERY BANK VOLTAGE IS NOT IN THE SPECIFIED LIMIT. CHECK FOR DEFECTIVE BATTERIES AND NUMBER OF BATTERIES.
ET	HIGH TEMPERATURE	CONNECTED PV PANEL CAPACITY (WATTS) IS NOT IN THE SPECIFIED LIMIT OR CHECK FOR THE FUNCTION OF THE COOLING FAN.
E:M	HARDWARE FAILURE	LIGHTNING MAY CAUSE HARDWARE FAILURE. IF CONTINUOUS BEEP SOUND AND ERROR MESSAGE EM IS SEEN, DISCONNECT THE PV PANELS BEFORE SWITCHING OFF THE DEVICE. THEN SWITCH OFF THE DEVICE. CONTACT THE INSTALLER FOR SERVICE ASSISTANCE.

SETUP MODE

● **Note: Before changing the default settings values of the device, ensure the maximum ampere and voltage ratings applicable for your battery type (SMF,LEAD ACIDetc) and brand. Blind settings may cause severe damage to the batteries and charge controller. Default values given are for lead acid batteries.**

ENTERING SETUP MODE:-Switch OFF the device and connect to the desired battery bank. To enter Setup Mode, connect the settings key to the 9-PIN D-Connector. Press and hold the ENTER button on the key and switch on the MPPT ON-OFF switch on the device till the charger enters the SETUP MODE on display. All the indicators and fan start to function. Press the ENTER button to scroll through the setup menu as shown below. Use the PLUS or MINUS buttons to increase or decrease the default values.

MENU	TYPE	DESCRIPTION	RANGE		
			MIN	DEFAULT	MAX
1.CAL-AMP (AMPS CALIBRATION)	Calibration	Increase or decrease this value to match the ampere shown on the display to the reading on your True RMS DC clamp meter. (FLUKE brand is recommended)	50	115	220
2.CAL-VOL (VOLT CALIBRATION)	Calibration	Measure the terminal voltage of the battery bank using a DC volt meter and equalise the reading shown in the display of the charger to your volt meter reading	-	-	-
3.BVH-CUT (BATTERY CHARGING HIGH CUT OFF VOLT)	Settings	Set the battery charging high voltage cutoff.	13V	14.5V	16V
4.MAX-AMP (CHARGING AMPS)	Settings	Set the maximum charging current cutoff (Max charging current value is recommended as 20% of the Ah of a single 12V C10 Battery connected in series. e.g. for a 150 Ah C10 Lead Acid battery, 30A is the recommended charging current)	3A	60A	60A
5.GRD-SOL (GRID TO SOLAR CHANGE OVER)	Settings	Set the battery voltage you prefer to shift automatically from grid power to inverter (solar power)	12V	14.0V	16V
6.SOL-GRD (SOLAR TO GRID CHANGE OVER)	Settings	Set the battery voltage you prefer to shift automatically from inverter to grid power	9V	11.0V	16V
7.BLK-LED (LOW BATTERY WARNING)	Settings	Set the low battery level of warning indication LED to blink	LB	11.7V	16V

Note: Values will be displayed as multiples of 10 (e.g. 14.5V will be displayed as 145)

NOTES

- 1) Solar panels should be grouped in such a way that the maximum Open Circuit Voltage (Voc) of the panels connected in series should not exceed the Maximum PV panel voltage recommended.
- 2) Safety precautions must be taken while grouping and connecting PV panels to the charge controller with high Voc input. (750 Volt DC current from the PV panel is highly dangerous. Never touch the terminals without safety gloves)
- 3) Extreme care should be taken while connecting High voltage solar power systems.
- 4) Earthing and wiring of high power solar system must be done under the supervision of a qualified electrical engineer
- 5) Never connect the PV panel connection to the battery input or the connection of the batteries to the PV input.
- 6) Never connect any of the grid line to any of the DC (PV or Battery) connection terminals. Use always weather proof highly insulated solar DC wires for PV panel grouping.
- 7) The installation and use must comply with the local safety instructions and standards in force.
- 8) Never use a flame or any kind of spark producing device near fully charged batteries as it may cause an explosion of the batteries and fire hazard.(eg: Checking battery water level under a candle flame light, spark from a metal cutter or spark from loose contact of battery connecting wires)**
- 9) We disclaim all responsibility and liability for damage, costs or losses resulting from an installation that does not comply with the instructions, a faulty operation or inadequate maintenance.
- 10) The use of the charger is in any case under the responsibility of the customer.
- 11) THIS EQUIPMENT IS NEITHER DESIGNED NOR GUARANTEED TO INSTALLATIONS ENTAILING POTENTIAL RISKS OF DAMAGE TO PEOPLE OR TO THE ENVIRONMENT

CAUTION



- Never try to change the default settings of the device without technical advice to avoid malfunction and hazardous result.

NOTES



www.ashapower.in E-mail- contact@ashapower.in